

Microcontroller

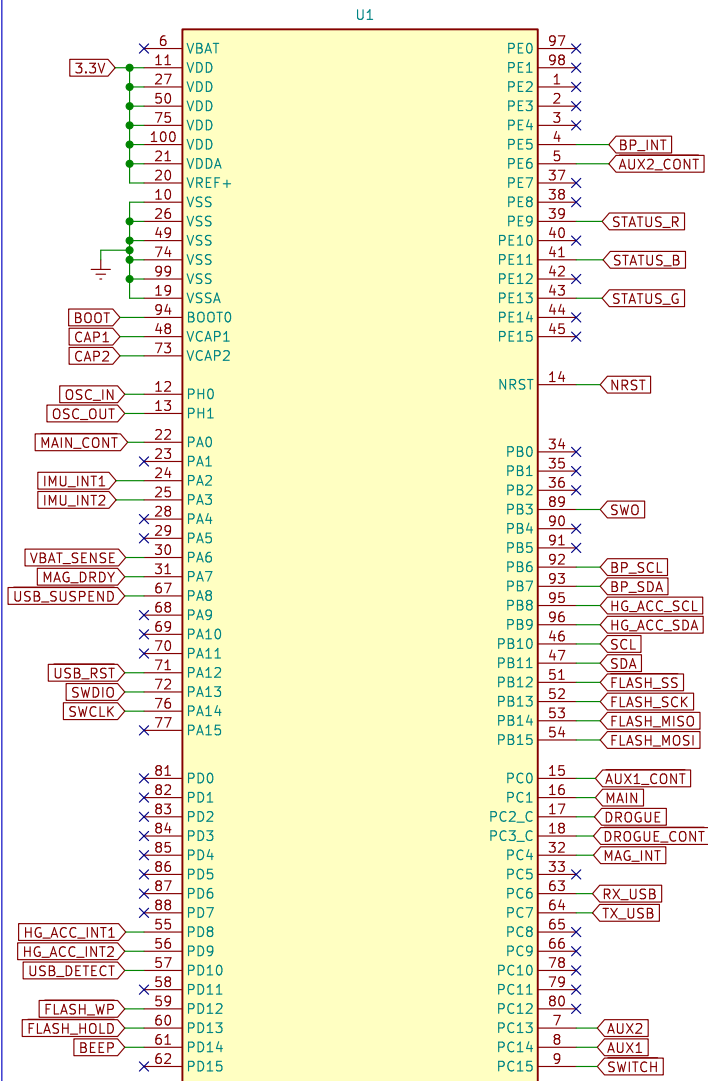

MCU Decoupling Caps

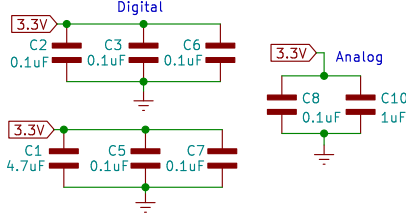

MCU Internal Regulator Caps

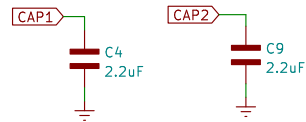

Firmware Status LED

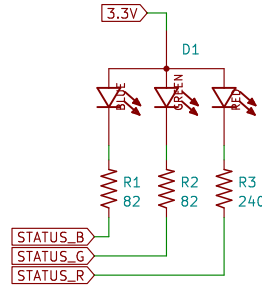

Boot Setting

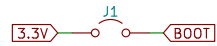

Mounting Holes

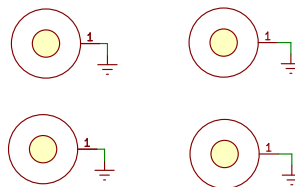

Peripherals

- USB
- Flash
- Parachute Deployment
- Buzzer
- Staging

File: peripherals.kicad_sch

Sensors

- Pressure
- Temperature
- IMU
- Magnetometer

File: sensors.kicad_sch

3.3V Power Supply

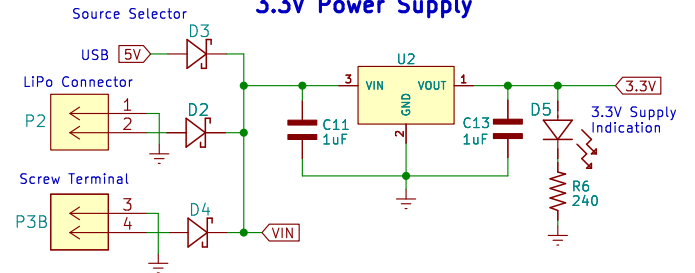

SWD Programmer

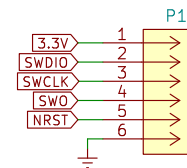

Battery Voltage Measurement

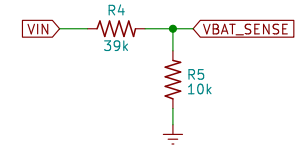

Crystal Oscillator

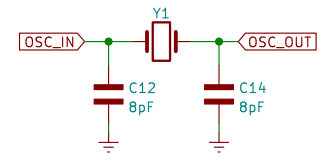

Author: Colton Acosta
Sun Devil Rocketry

Sheet: /
File: Full-Flight-Computer.kicad_sch

Title: Flight Computer

Size: A4 Date: 2022-05-30

KiCad E.D.A. kicad 7.0.1

Rev: 1.0

Id: 1/3

Inertial Measurement Unit

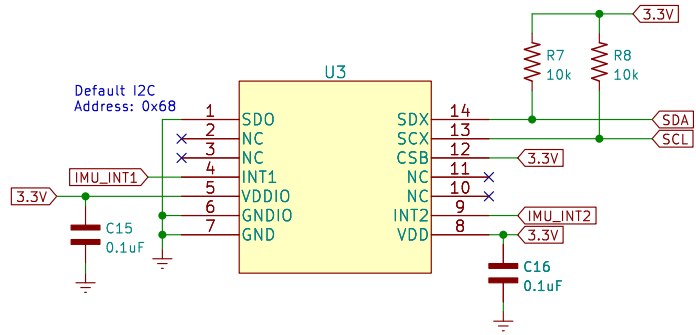

Barometric Pressure Sensor and Temperature Sensor

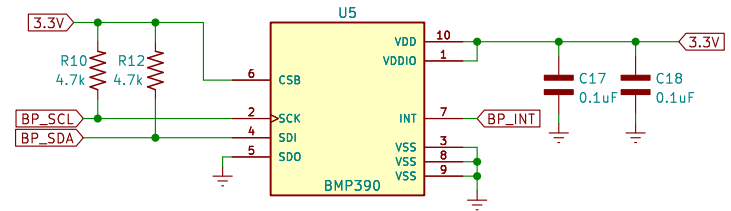

Magnetometer

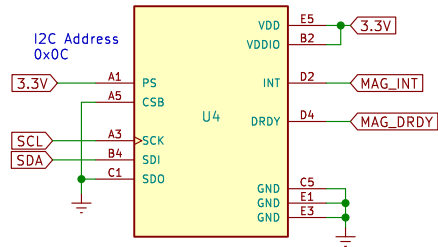

High G Accelerometer

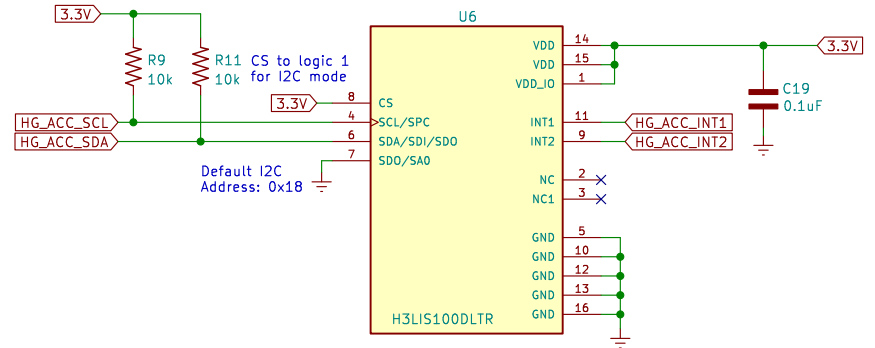

Sheet: /Sensors/
File: sensors.kicad_sch

Title:

Size: A4
KiCad E.D.A. kicad 7.0.1

Date:

Rev:
Id: 3/3

Main Chute Deployment

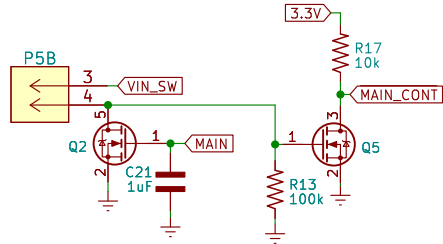

Drogue Chute Deployment

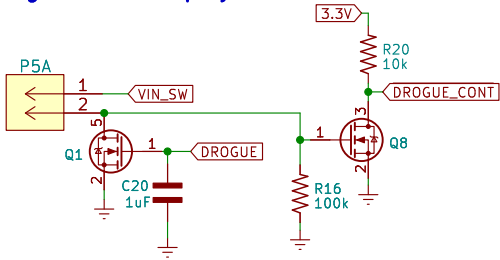

Auxiliary Ports

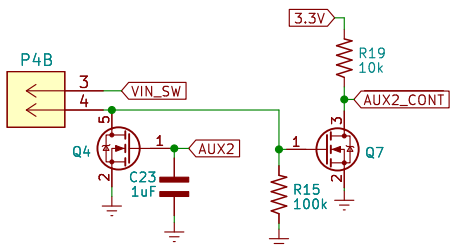
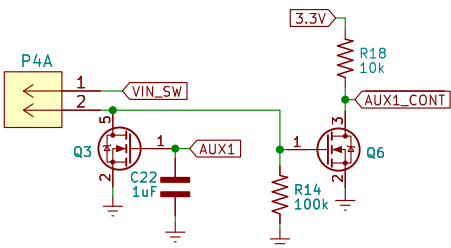

USB Transceiver

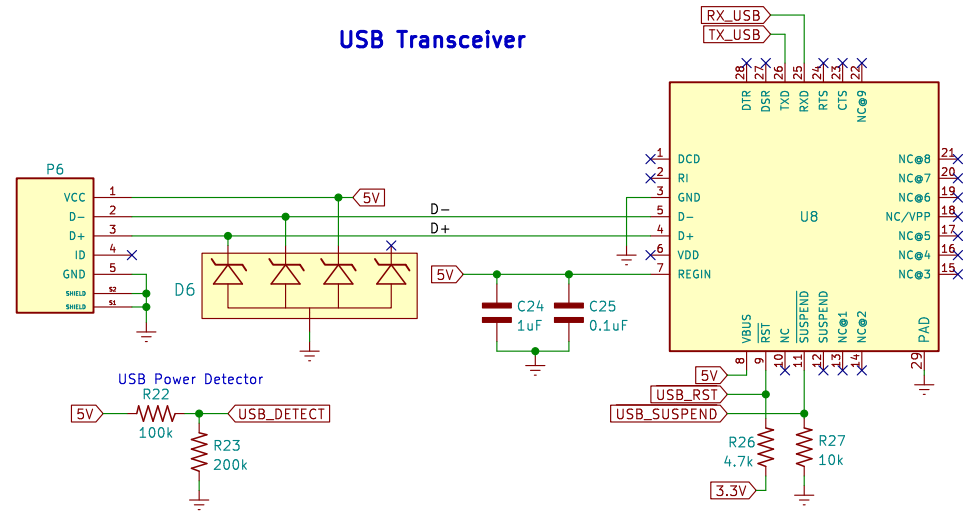

Flash

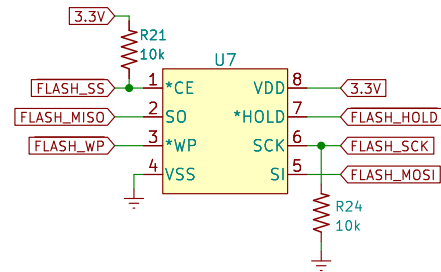

Arming Switch

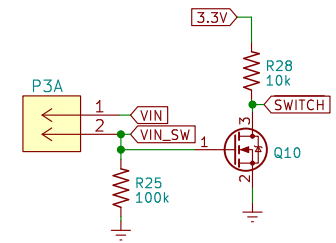

Buzzer

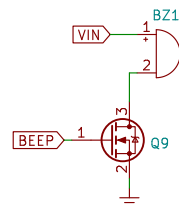

Sheet: /Peripherals/
File: peripherals.kicad_sch

Title:

Size: A4

Date:

KiCad E.D.A. kicad 7.0.1

Rev:

Id: 4/3